



FOR RADIANT SPACE HEATING APPLICATIONS

Model SH-24-208

Four-Chamber Tankless Electric Heat Source

Description: The SH-28-208 is designed for use in residential and commercial applications for hydronic space heating and potable water heating. It is ideal for radiant floor heating, baseboard, hydro-heat pump and snow melting systems. With optional equipment, it can be used as a single heat source in combination systems for potable hot water and radiant heating. This on-demand tankless water heater is a powerful replacement for traditional tank-type heaters and is the enabling technology for use as backup to active renewable energy systems such as solar and geothermal water heating systems. The temperature activated control works effectively in re-circulating systems and in combination with tank-type heaters. A minimum 150 AMP whole-house electrical service is recommended.

Features:

- UL 834 Listed for Space Heating Applications
- No minimum flow required for activation
- Built-in DSM Utility Integration option
- Compatible with Home Energy Management
- Heats fluid mixtures including ethylene glycol
- Very small & compact with no moving parts
- Lightweight modular construction
- Standard 3/4 inch plumbing connections with no flow restrictions
- Compatible with all plumbing designs including recirculating, tubing and manifold systems
- Microprocessor digital control
- Power sharing power control technology
- Heats continuously and only when needed
- Self-diagnostics with redundant safety devices
- High performance DuPont polymer nylon chamber material
- Built-in leak detection and alarm
- Rust & corrosion resistant

Specifications:

Heat Output (max.): **81,910 BTU**
 Power Rating (max.): **24KW**
 Voltage Rating (Nominal): **208 VAC**
 Current Rating (max.): **115 AMPS**
 Panel Load Factor (40%): **46 AMPS**
 Energy Factor: **0.99+**
 Heating Elements: **6000 watts x 4**
 Circuits Required: **4 ea. 2-wire w/ ground (#8cuAWG)**
 Breakers Required: **Four (4), double-pole**
 Breaker Size: **40 AMPS each x 4 (Optional 75x2)¹**
 Temp. Output (dial): **90°F to 130°F (32°C - 52°C)²**

¹ Install included jumpers on control board for this option and use 2 ea. 2-wire circuits w/ground #6cuAWG

² Factory set to 120°F – Custom temperatures to 160°F by special order.

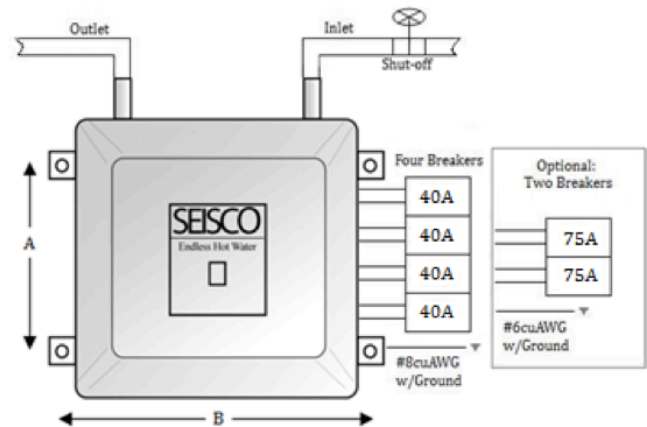
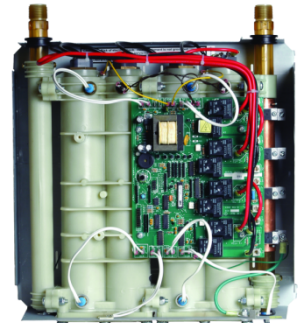

Flow Ratings:

Rise (°F)

@ Flow (GPM)

81°F @ 2.0 GPM

65°F @ 2.5 GPM

54°F @ 3.0 GPM

30°F @ 4.0 GPM

Rise (°C)

@ Flow (LPM)

42°C @ 8 LPM

34°C @ 10 LPM

27°C @ 12 LPM

21°C @ 16 LPM

Mounting Holes:

A: 14 3/4" (362mm)

B: 16 1/8" (410mm)

Dimensions:

Weight: 23 lbs. (10.4 kg)

Height: 15 3/4" (400mm)

Width: 15 3/4" (400mm)

Depth: 6 1/4" (159mm)

Fittings: 3/4" (200mm)

Approvals:

UL CSA NSF HUD NEC