

Technical Data Sheet

Model: AB-204D
Description: Solar powered ventilation fan; remote mounted PV panel; curb-mounted housing; powder coated finish
Revision: 2
Date: 24-Apr-10
DCN: TDS-1008

Top View

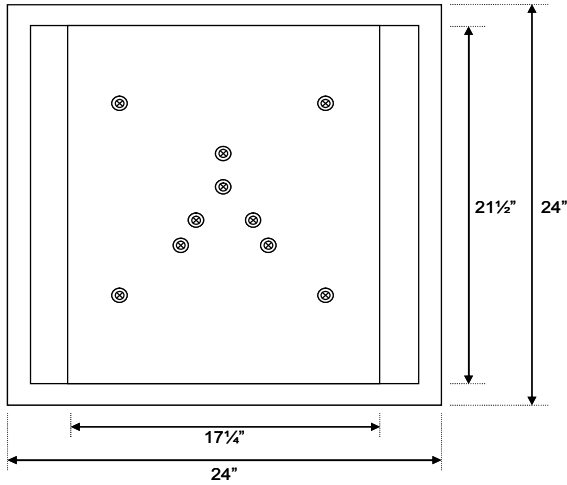

Bottom View

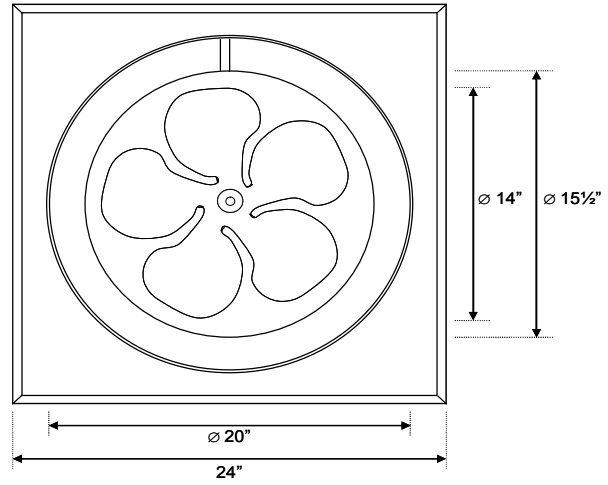

Front View

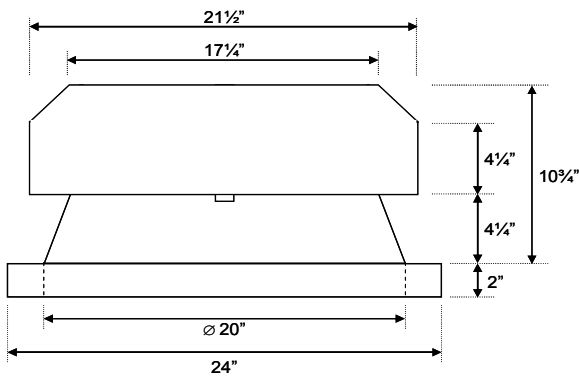

Side View

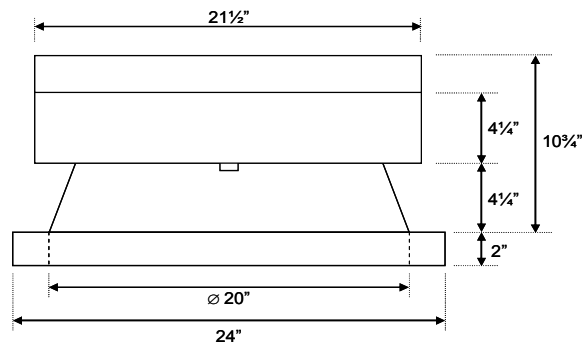

Remote Solar Panel

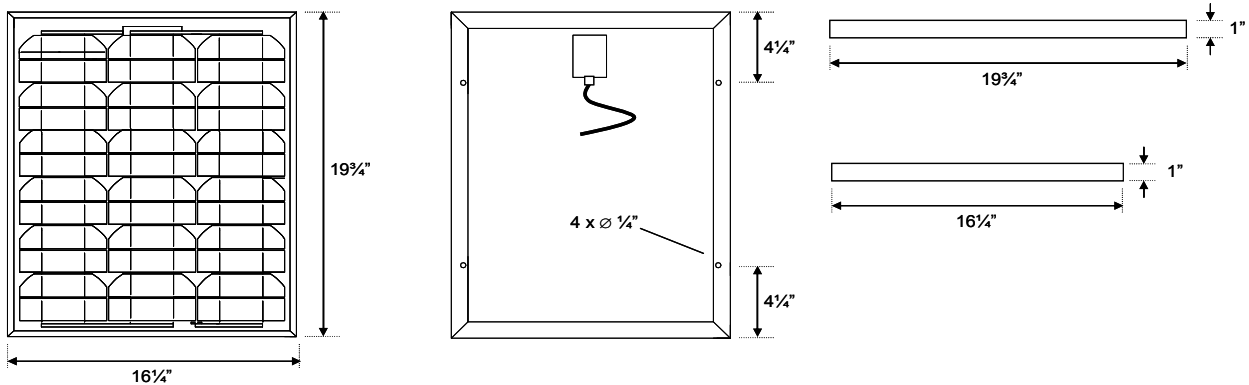

Model AB-204D Specifications

Material of Construction

Fan Housing: 24 GA Zincolume (ASTM A792 - 55% Aluminum-Zinc Alloy Coated by Hot-Dip Process)
Rodent Screen: 1/4" Mesh Stainless Steel Screen
Fan Blade: Proprietary 14" 5-Wing Aluminum Blade with Integrated Balanced Hub
PV Panel: Anodized Aluminum Frame with Impact Resistant Tempered Glass
Finish: Powder Coated; TGIC polyester coating; 3-6 mils average thickness
Hardware: Stainless Steel Brackets & Fasteners

Electrical

Motor: Proprietary 38 V variable speed DC motor
PV Panel: Proprietary 20 W monocrystalline panel, 36 cells
Internal Wiring: 18 AWG
Remote Cable: SJEOOW (or equivalent) UV/Weather Resistant Cable; 15' x 18AWGX2C
Termination: UV/Weather Resistant Quick Disconnect Plugs

Performance

Air Movement: 1350 CFM @ 0.0 inH₂O
Noise Level: < 1 sones (< 30 dB)
Wind Rating: +115 PSF/-115 PSF; +170 MPH Wind Speed Equivalence*

Weight Load

Fan Unit: 22 LBS
Remote Panel: 6 LBS

* Wind speed equivalence based on 30 foot mean roof height in Exposure B; wind zones 1-3; all roof pitches apply

