

## ASSEMBLY INSTRUCTIONS for Wheels Reel (FG-1B) and Blanket Handler (BL-IGEW)

**PLEASE READ ENTIRE INSTRUCTIONS CAREFULLY BEFORE PROCEEDING**

### Four Easy Steps:

If you need additional assistance, contact us at [info@feherguard.com](mailto:info@feherguard.com) or call 905-876-4766 Monday to Friday 8:30 a.m. to 5:00 p.m. Eastern Time.

- Before starting assembly, trim cover to clear the inside top edge of your pool.  
Recommended Solar Cover is 12 mil with round bubbles.
- Allow an extra 4" (10 cm) on cover length if installing the reel at mid-point or off-center.

### REEL SYSTEMS COMPONENTS AND PREPARATION:

#### Getting started:

Ensure that your system has two cartons consisting of one end carton and one tube set carton.

**Tools required for assembly:** Recommend Safety Glasses

- Portable drill (driver bit provided)
- Tape measure
- Pencil and Scissors

**Tube Carton Parts List:**  
2 end tubes and 1 center tube

#### FG1B Parts List:

2 Wheels      2 Wheel Stops  
2 Handles    2 Bearings  
2 Plugs for 3" diameter tubes  
2 Plugs for 2 1/2" diameter tubes  
Hardware Kit: 20 Strap Plates  
10 Straps    10 Plastic Screws  
25 Self-drilling Metal Screws  
1 Driver Bit

#### BL-IGEW Parts List:

2 End Brackets    4 Casters  
2 Handles        2 Bearings  
2 Plugs for 3" diameter tubes  
2 Plugs for 2 1/2" diameter tubes  
Hardware Kit: 20 Strap Plates  
10 Straps        10 Plastic Screws  
25 Self-drilling Metal Screws  
1 Driver Bit

### STEP 1: SOLAR REEL PLACEMENT:

A. Determine the best location for the reel system. *The widest point of the pool is the preferred locations (see Fig. 1 below). Small cover extensions may be folded in to avoid using a wider reel.*

B. At the determined location, measure the width of the pool and add 6" (15 cm).

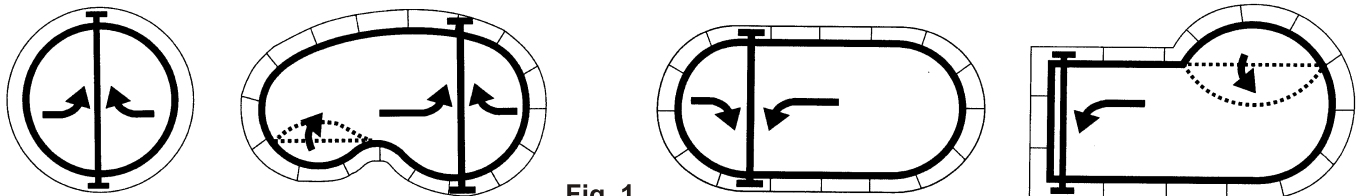

Above-Ground pools with deck

Fig. 1

### STEP 2: TUBE ASSEMBLY

Configuration for L18, L18M\*, IG20, IG20M\*, IGL12 and LC25 Tube Sets

A. Ensure minimum of each end tube is inside center tube (see table below right).  
Less than minimum insert causes screws to loosen and/or tubes to split.



Fig. 2a

Insert both end tubes equal distance into center tube and mark on center tube where inner tubes end

Tube	Min. Insert	Max. Width	Max. Wet Cover Weight	Max. Cover
IG20	12"	20'6" (6.3 m)	60# (27.3kg)	20x40
IG20M*	12"	20'6" (6.3 m)	60# (27.3kg)	20x40
L18/L18M*	9"	18'6" (5.7 m)	60# (27.3kg)	18x36
IGL12	8"	12' (3.6 m)	44# (20.0kg)	12x60
LC25	24"	25' (7.8 m)	75# (34.1kg)	25x50

\*Mill tubes tarnish over time. Anodized tubes help reduce tarnishing.

### Configuration for IG20/IG24EX Tube Set (2 tube set cartons)

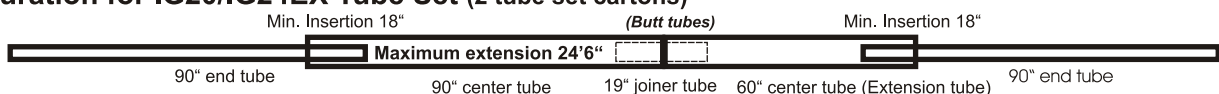

Fig. 2b

Please refer to extra Instructions and extra hardware contained inside extension tube.

This tube set is used only for irregularly shaped pools up to 24' at widest point - up to 650 sq. feet maximum.  
For larger pools use Blanket Handler with FG-LC25 Tube Set (up to 25' x 50')

Tube	Min. Insert	Max. Width	Max. Wet Cover Weight	Max. Cover
IG24EX	18"	24'	50# (22.7kg)	(650sq')
Extends IG20 to 24'6" (7.6m)				

## STEP 2: TUBE ASSEMBLY - CONTINUED

THIS STEP REQUIRES A TOTAL OF 12 SELF-DRILLING SCREWS **DO NOT pre-drill holes or over-tighten screws.** (24 SELF-DRILLING SCREWS FOR IG20/IG24EX)

- Lock tubes together by rotating the center tube in the opposite direction to end tube. **HOLD TUBES LOCKED WHILE YOU INSTALL FIRST SELF-DRILLING SCREW ON A DRILL LINE, 1" (2.5 cm) back from end of center tube at Location "C1"** (see Fig. 3 & 4).
- Place 2 more self-drilling screws at Location "C2" & "C3" - 1 screw at every second drill line around tubes (see Fig. 3).
- At "D" locations install 3 screws around the center tube at every second drill line, 1" (2.5 cm) back from where you marked the end of the inner tube from Fig. 2A (see also Fig. 3).
- Repeat for other end tube.

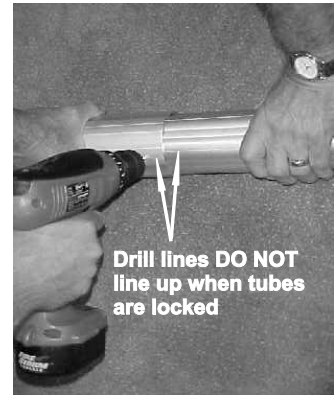
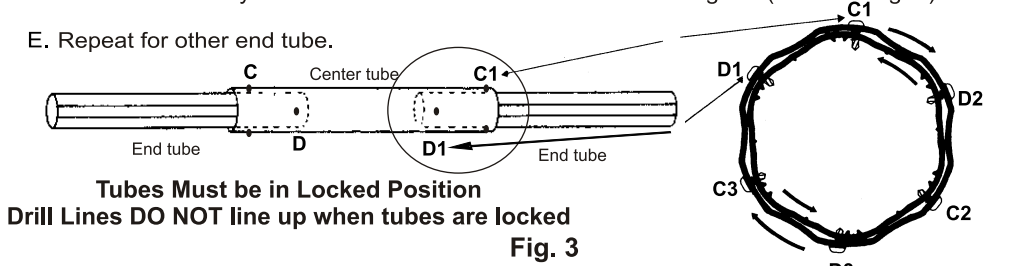

Fig. 4



**Tubes Must be in Locked Position**  
**Drill Lines DO NOT line up when tubes are locked**  
Fig. 3

## STEP 3: ASSEMBLE ENDS

Assemble in numerical order (see Fig. 5 or 6):

- Insert Plug (#1) into End Tube. (Use the 2 plugs with appropriate diameter for your tube - discard other set)
- Place Bearing (#2) inside End Bracket or Wheel (#3).
- Push Handle (#4) through Bearing and into Plug.
- Insert 1 self-drilling screw (#5) through tube in line with bump on plug rim and 1" (2.5 cm) from tube end. (see Fig. 7).
- Repeat for other end.

5. Insert Screw 1" (2.5 cm) from tube end (See Fig. 7)

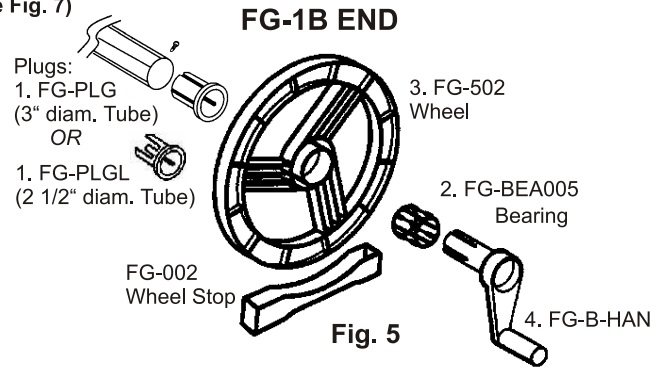

Fig. 5

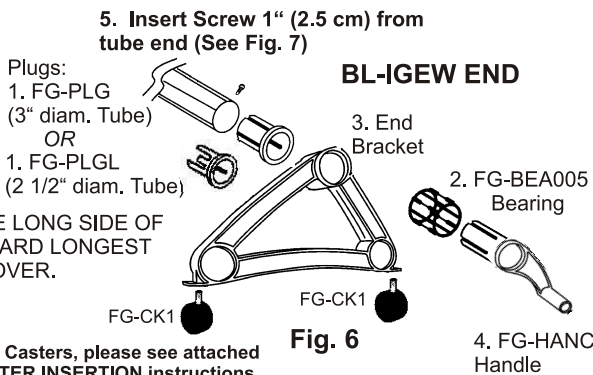

Fig. 6

**BL-IGEW PLACE LONG SIDE OF TRIANGLE TOWARD LONGEST SECTION OF COVER.**

To Insert Casters, please see attached **CASTER INSERTION** instructions.

**IMPORTANT:**  
5. When ends are assembled insert screw through tube in line with bump on plug rim, 1" (2.5 cm) from tube end - at **BOTH** ends.



Fig. 7

## STEP 4: STRAP ATTACHMENT

Attach a Strap Plate to **EACH** end of all Straps provided (see Fig. 8).

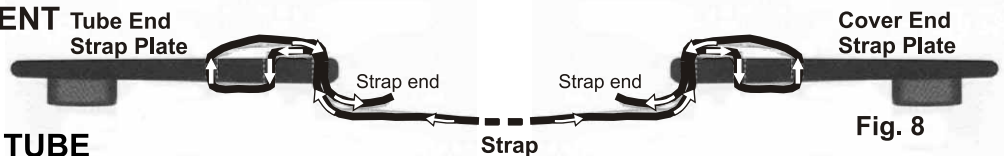
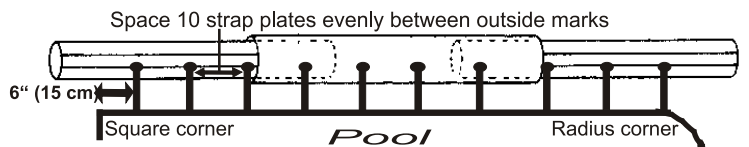

Fig. 8

## STRAP ATTACHMENT - TO TUBE

- Mark strap plate location on tube drill lines. First strap plate is placed 6" (15 cm) in from inside edge of pool or at the start of the radius corner (see Fig. 9).
- Attach strap plates to the tube with metal screws (see Fig. 10). **DO NOT pre-drill holes or over-tighten screw.** Use all straps provided.



First strap plate is placed 6" (15 cm) in from inside edge of pool or at start of radius corner. Place system across widest point of pool if radius corners are greater than 6".

Fig. 9

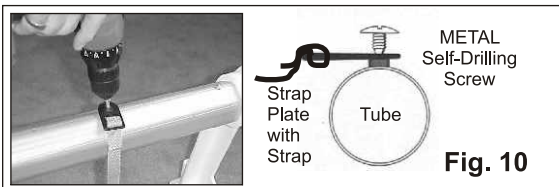
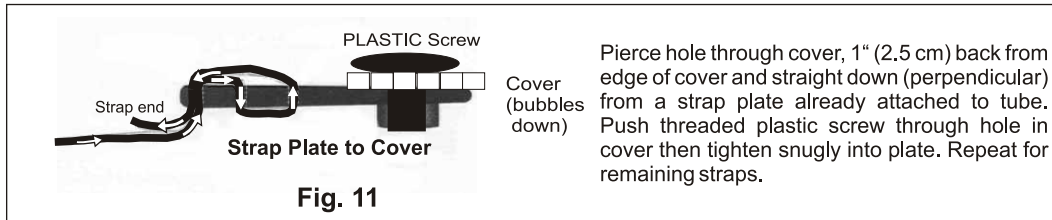

Fig. 10

## STEP 4 (continued): STRAP ATTACHMENT - TO COVER

D. Choose either Fig. 11 OR Fig. 12 - the appropriate instructions below for your pool shape. If you have determined a mid-pool or off-center placement, it will be easier if you move the cover away from the pool and fold it (bubbles in) on a flat surface.

### For Systems Placed at Pool End (Rectangular Pools) (Fig.11)



Pierce hole through cover, 1" (2.5 cm) back from edge of cover and straight down (perpendicular) from a strap plate already attached to tube. Push threaded plastic screw through hole in cover then tighten snugly into plate. Repeat for remaining straps.



### For Systems placed at Mid-Pool or Off Center (Round or Irregularly Shaped Pools) (Fig. 12)

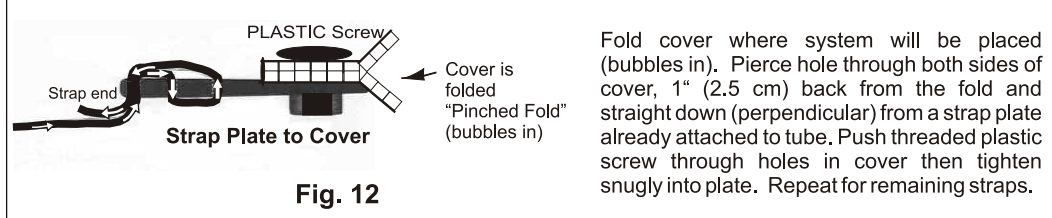

Fold cover where system will be placed (bubbles in). Pierce hole through both sides of cover, 1" (2.5 cm) back from the fold and straight down (perpendicular) from a strap plate already attached to tube. Push threaded plastic screw through holes in cover then tighten snugly into plate. Repeat for remaining straps.

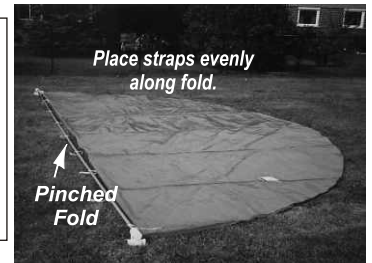

E. When you start to roll up the cover, all straps must take hold of the cover at the same time. Adjust the strap lengths if necessary.

### Safe Use of Your Solar Reel:

- Solar Reel systems are designed solely to remove solar covers and are not made to support people or any other weight.
- Solar covers must be completely removed before entry into the pool. Under no circumstances, should one swim in a pool partially covered with the solar cover.

### Care and Storage:

Check screws periodically and tighten, if necessary. The solar reel may be stored outside for the winter. It is not recommended to disassemble it for storage inside.

## ACCESSORIES AND OTHER PRODUCTS AVAILABLE FROM YOUR DEALER:

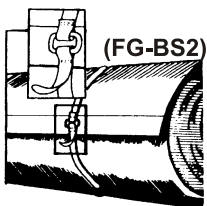

- FG-FASKIT TUBE & BLANKET FASTENING KIT (10 sets straps & fasteners per pouch)
- FG-PFS TUBE AND BLANKET FASTENERS (10 sets fasteners per pouch)
- FG-RS26 REEL STRAPPING (10 Straps 26" per pouch)
- FG-RS50 REEL STRAPPING (1 - 50' Roll)
- FG-BS2 BLANKET STRAPS (2 x 54" per pouch)
- FG-WPS WHITE PROTECTIVE SHEET (20' x 40" sheet with Velcro)
- FG-MPR MID-GRIP PULL ROPE

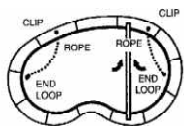

Clips to side for easier access when cover is rolled.

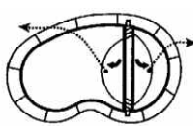

Makes pulling cover onto the pool easier.

### MID-GRIP PULL ROPE ACCESSORY (FG-MPR) (Available from your Dealer)

For ease of pulling cover on pool, we suggest using the Mid-Grip Pull Rope accessory. This easily attaches to the cover as shown at the left.



### VACUUM HOSE REEL Available through your local dealer

#### FG-VHG

- Holds up to 50' of 1 1/2" Vacuum Hose
- Durable polyethylene construction
- Also for Pool Backwash Hose, Electrical Cord (100') or Garden Hose (100')



#### FG-VHG



## Five Year Warranty:

FeherGuard warrants for a period of five years from the date of delivery to the original consumer purchaser, that the Blanket Handler or the Wheels Reel Solar Cover Reel System shall be free from defects in workmanship or material, under normal use and in accordance with FeherGuard's written installation and use instructions. FeherGuard at its option shall supply free of charge any part found to be defective in workmanship or material.

Any implied warranties are limited in duration to the five-year period from the date of delivery to the original consumer purchaser.

This Warranty is void if there is evidence of purchaser abuse, improper installation or normal wear.

FeherGuard will not be liable for incidental or consequential damages resulting from any defects in workmanship or material. Some States/Provinces/Countries do not allow the exclusion or limitation of incidental or consequential damages, so the foregoing limitations or exclusions may not apply.

This Warranty gives the claimant specific legal rights. The provisions of this Warranty are in addition to and not a modification of or a subtraction from the statutory warranties and other rights and remedies contained in applicable local legislation.

To validate Warranty, return this registration form within 30 days of purchase. You may also register your warranty online on our Home Page at [www.feherguard.com](http://www.feherguard.com).

Warranty claims should be processed through your Dealer and include your proof of purchase.

FeherGuard Products Ltd.  
821 Main Street East  
Milton, Ontario CANADA  
L9T 3Z3

**Specifications subject to change without notice.**

1/08

**Thank you for buying the Blanket Handler or The Wheels Reel Solar Cover Reel System.  
We know it will make solar cover handling easy for you.**



### FeherGuard "Five Year" Warranty Registration

Please Print

PURCHASER: \_\_\_\_\_

ADDRESS: \_\_\_\_\_ CITY: \_\_\_\_\_

STATE/PROVINCE/COUNTRY: \_\_\_\_\_ ZIP/POSTAL CODE: \_\_\_\_\_

MODEL #

STORE LOCATION

PURCHASE DATE